

VIDEO PROJECTOR

User Manual

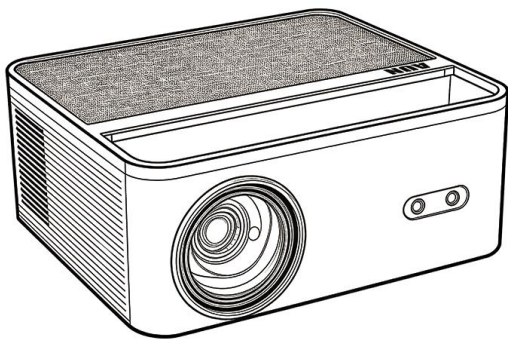

Congratulations On Becoming Of The AUN Projector Family.

Thanks for choosing AUN!

May Your AUN Projector Illuminate Your Life And Bring You An Extraordinary Visual Journey.

Please read this user manual carefully, follow the instructions, and keep it in a safe place for future reference. AUN consistently attaches great importance to product quality and customer satisfaction—feel free to share them with your friends! Should you encounter any issues during use, please do not hesitate to let us know. Our after-sales team will provide you with the best solution promptly. All products purchased from AUN are covered by a 1-year warranty.

You can reach us via the following channels:

E-mail: kp@aunstore.com

WhatsApp: +86 15920076893

Telegram: +86 18124179670



Website

www.aunstore.com



Whatsapp

+86 15920076893

We look forward to bringing you more excellent products in the future.

Kind regards,

AUN Support Team

Packing List

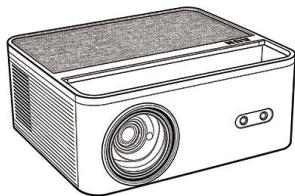

A45 Projector



Remote control



User Manual

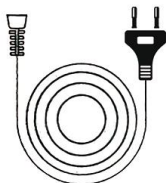

Power adapter

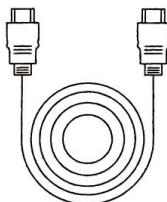

HDMI cable

Due to differences in production batches, there may be some variations in the accessories. Please refer to the actual items for details.

Projector Ports and Connection Introduction

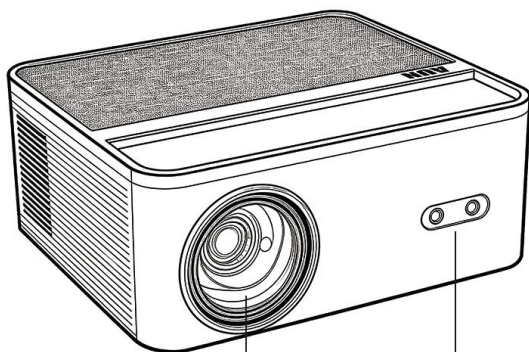

Lens

Laser Rangefinder / Infrared Receiver

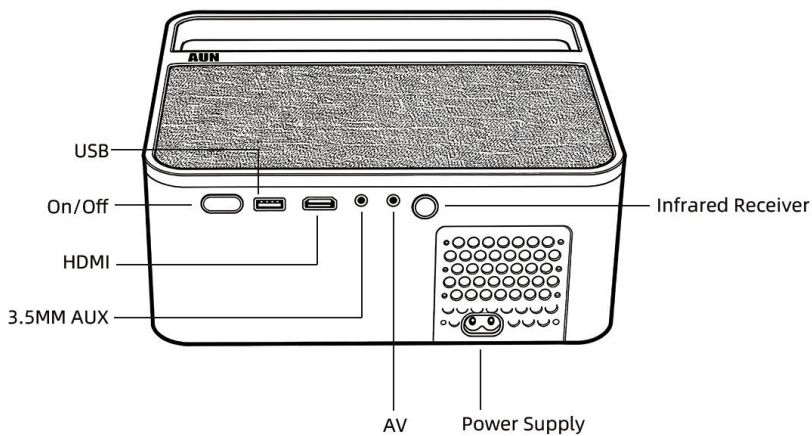

USB

On/Off

HDMI

3.5MM AUX

AV

Power Supply

Infrared Receiver

Remote Control

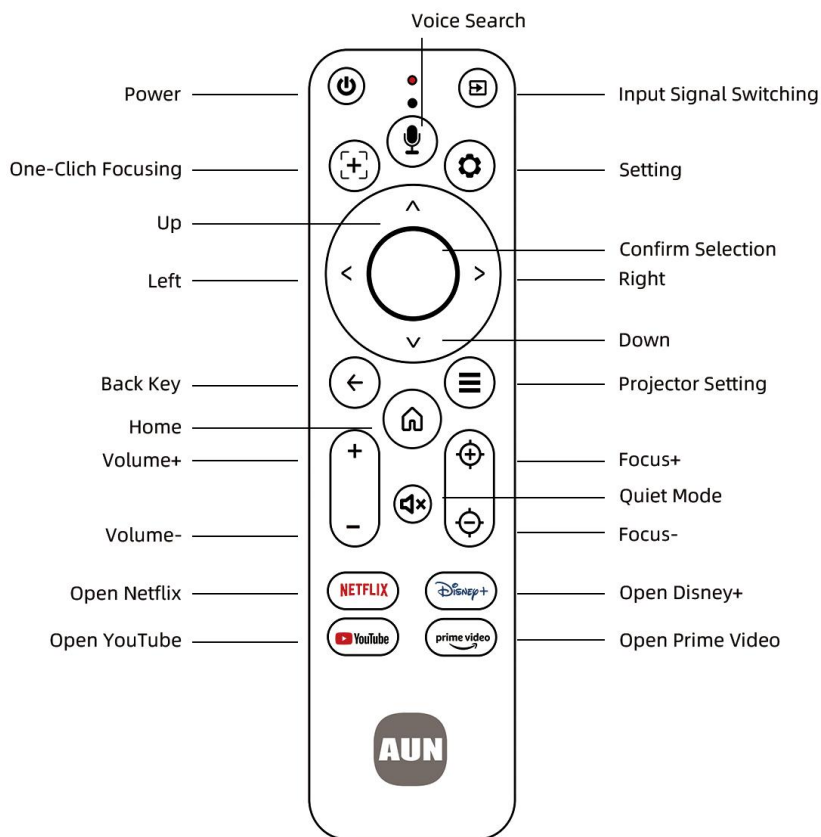

Specifications

Item	Details
Model :	A45 Pro
Display Technology :	4" LCD
Native Resolution :	1920X1080(FULL HD)
Max Supported Resolution:	4K
System :	Android 11 (Google ATV)
RAM:	1 G
ROM:	8 Gb
Aspect Ratio :	4:3/16:9
Screen Size :	47"-250" / 3.92 - 20.83 ft
Projection Distance :	1.39-6.8m / 4.56 - 22.31 ft
3D Function :	Red Blue 3D
Focus :	Electric (Manual & Auto)
Keystone :	Automatic vertical
Input :	HDMI/USB
Input Voltage :	63±5W
Size :	22.3 x 19.8 x 9.7cm
Weight :	1.55kg
Installation Type :	Front/Rear/Ceiling

Safety Instructions

- Please read these instructions carefully to ensure safe operation of the product.
- Follow these instructions to prevent injury or damage to the product operator or others.

WARNING and CAUTIONS

- **Do not install the projector in poorly ventilated areas.**

Keep the rear of the projector well-ventilated to ensure proper cooling and prevent overheating. Never block the ventilation vents.

- **Avoid installing the projector in dusty or smoky environments.**

Do not place the projector near temperature or smoke sensors, as this may lead to sensor malfunction.

- **Do not expose the projector to direct airflow from heating or air conditioning units**

Direct blasts of warm or cool air can cause moisture condensation or temperature fluctuations, resulting in product failure.

- **To reduce the risk of electric shock, do not attempt to disassemble or repair the projector yourself.**

Improper repairs can cause electric shock or personal injury.

If the product is defective, please contact our after-sales service team at: kp@aunstore.com

Quick Start Guide

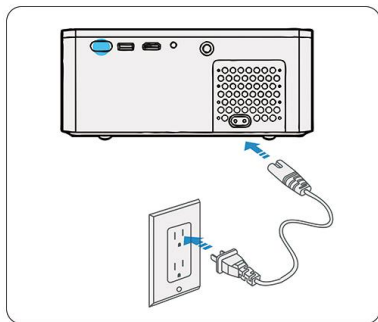

• Power Connection

Connect the projector to a power source using the provided adapter.

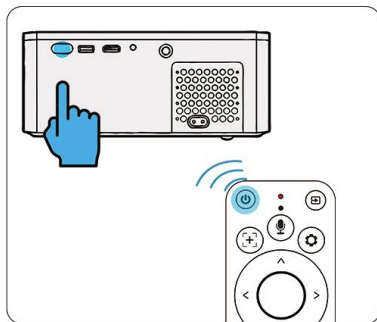

• Power On

Press the power button on the projector to turn it on.

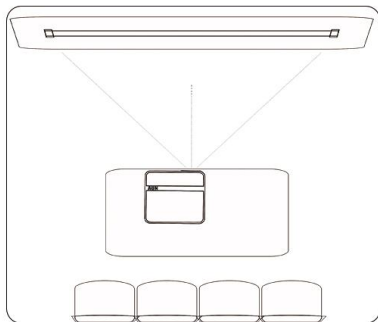

• Quick Focus

Align the device with the screen/wall and the image will auto-correct in moments.

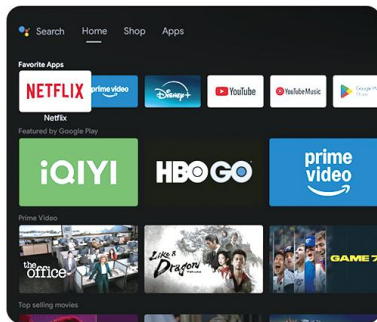

• Connect to WIFI

You can now enjoy the giant screen cinema.

Quick Start Guide

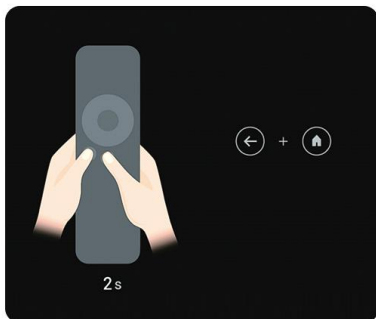

• Remote Control Pairing

Press the "←" and "Home" buttons at the same time to pair the remote control.

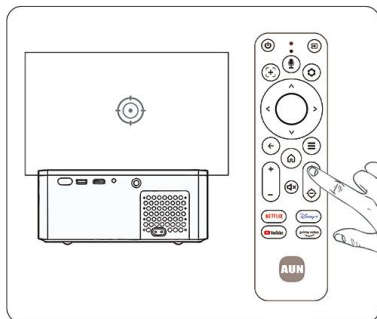

• Fine-tuning

Use the F+ and F- buttons on the remote control to fine-tune the image sharpness for optimal clarity.

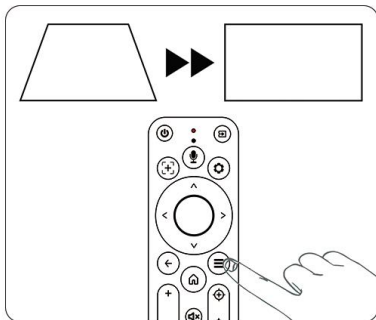

• Image Correction

After the projector is turned on, it will automatically perform the trapezoidal correction.

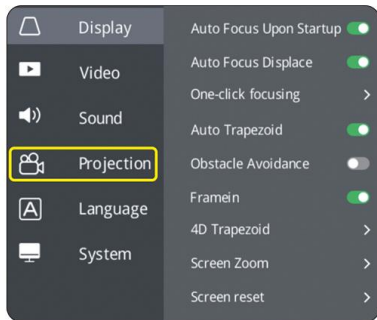

• Manual Correction

For manual adjustment, press and hold the "⊞" key on the remote, then go to Projector Settings - Display - 4D Keystone to adjust.

Image Adjustment

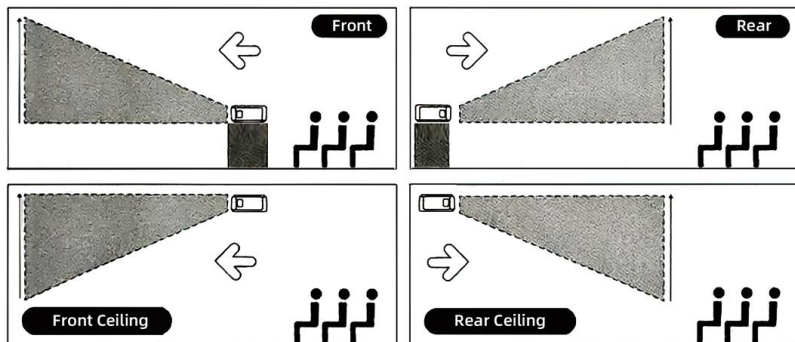

Projection Size

Your projector supports a screen size range of 47"-250". Below are the approximate projection distances for common screen sizes:

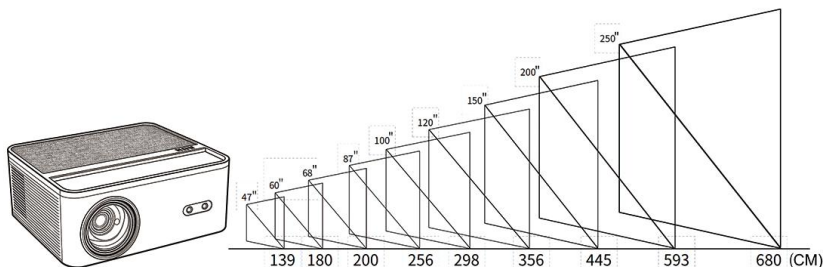

App Navigation & Settings

• Home Menu

This page lists all apps. If you cannot exit an app due to network issues, press the Home () button on the remote to return to the Home screen.

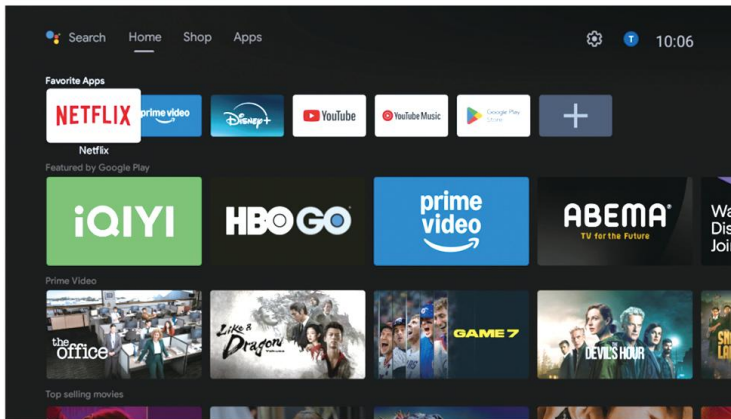

• My Apps

This page shows all downloaded apps and software. You can also download additional content via Google Play Store.

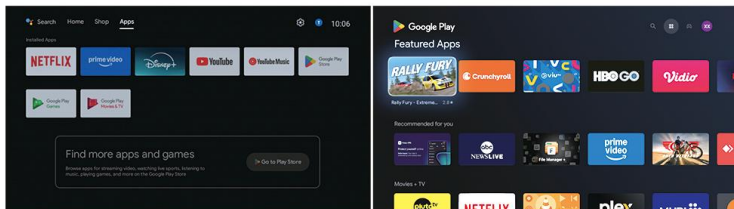

Google TV Settings

• Setting

Press the (⚙️) button to open the settings menu, where you can adjust all Google TV Store-related settings, including IP and app configurations.

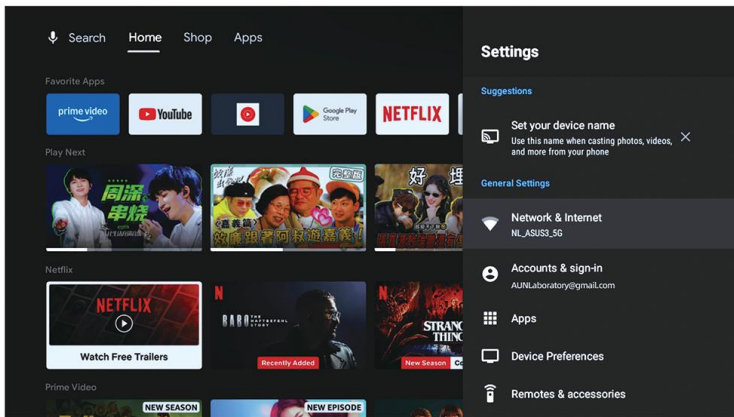

• Setting Parameters

Press the (⊞) button on the remote to enter the projector settings interface, where you can adjust various projector-related parameters.

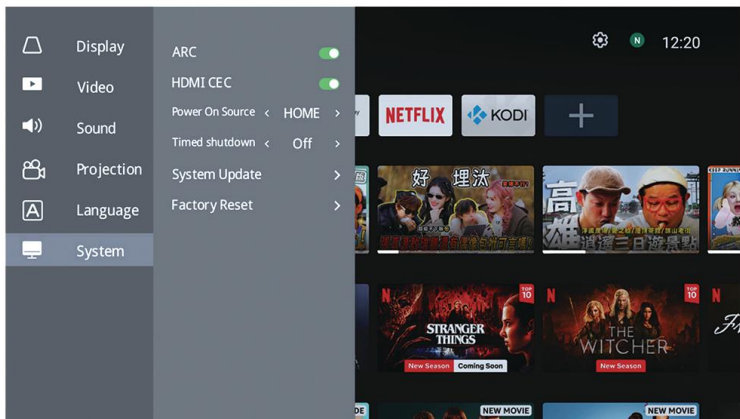

Google TV Settings

• Bluetooth Device & Remote Control Pairing

Press the settings (⚙️) button, open Remotes & Accessories in the settings menu, select Add accessory/remote, then find and connect your compatible device or remote.

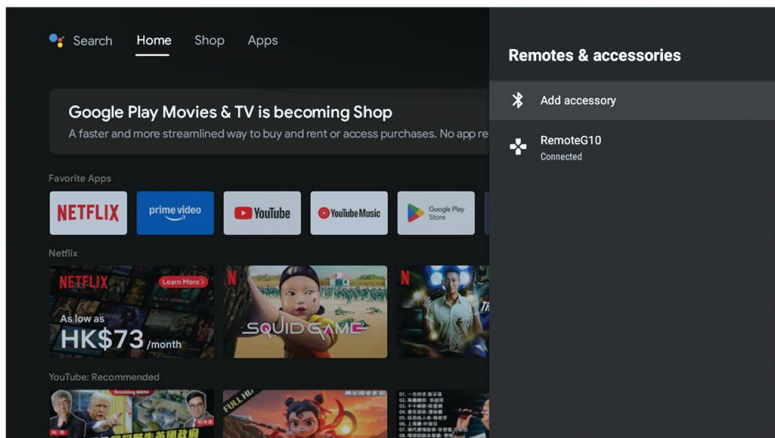

Tips

- Ensure a stable network connection with bandwidth $\geq 100\text{Mbps}$ when using GTV.
- Most issues with Google TV apps are compatibility-related, not projector problems.
- Due to HDCP protocol, wireless streaming of Netflix/Hulu is not supported on LCD projectors.

• Solution:

It is recommended to install and use the corresponding apps directly within the projector's Google TV system, or play content via a wired HDMI connection to a compliant device.

Mobile Phone Mirror Image

Keep your mobile phone and projector connected to the same WIFI network.

In the screen projection function of an Android phone, you can select the projector.

In the screen projection function of an Iphone, you can select the projector.

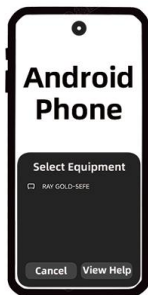
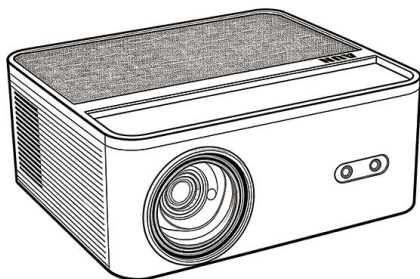

• **Should the issue continue, please contact our support team**



Email: kp@aunstore.com



Youtube: AUNProjector



WhatsApp: +86 15920076893



Telegram: +86 18124179670

Q1: WiFi Connection Unstable / Poor Streaming Performance

- Place the projector closer to the WiFi router for stronger signal
- Use 5GHz WiFi for faster speed and smooth video streaming
- Use 2.4GHz WiFi for better stability over longer distances
- Keep the projector away from interference (walls, metal objects, other electronics)
- Restart the router and reconnect the network
- Forget the WiFi network and reconnect if the issue persists

Q2: USB Device Not Detected

- Ensure the USB drive is properly inserted
- Format the USB drive to FAT32 or exFAT
- Check that files are in supported formats
- Try using a different USB port or another USB drive
- Restart the projector and reconnect the USB device

Q3: Light Spot Check

- Display a solid color screen (red, green, blue, or white)
- Carefully inspect the screen for any bright or dark spots
- Clean the lens surface before checking
- If abnormal spots remain visible, contact customer support for assistance

Q4: How to do factory data reset

- Navigate to Device System.
- Select Reset or Reset Options.
- Choose Factory data reset.
- You will see a warning. Confirm your choice
- The projector will restart and begin the reset process, which may take several minutes.
- Warning: This will erase all your accounts, installed apps, and custom settings.

Q5: Why is there sound but no image when screen mirroring Netflix from my phone?

- Streaming services like Netflix, Prime Video, and Disney+ enforce copyright restrictions that block phone screen mirroring. YouTube is the only major platform without this limitation.
- For reliable playback, connect a laptop to the projector using an HDMI cable.
- Another option is to use a Fire TV Stick with the projector.

Q6: What if the remote control is unresponsive?

- Test the remote by pointing its IR emitter at your phone's camera while pressing buttons.
- If you see a steady purple-red light in the camera view, the remote is functional—this indicates a potential motherboard issue. Please contact support for a warranty replacement.
- If no light appears, the remote is defective. Reach out to support to request a new remote.

Q7: How to install APK

- Please find and install your desired APK from the built-in app store.
- If the app is unavailable in the app store, you may install it using a USB drive.
- Insert the USB drive into the projector's USB port.
- Open the File Manager on the projector, locate the USB drive, and find the APK file.
- Select the APK file and follow the on-screen instructions to complete the installation.

Q8: No display signal

- Confirm correct input source is selected. Check HDMI/USB connection. Restart the device.

Q9: Blurry image

- Adjust focus ring and keystone correction. Clean the lens. Ensure correct

Q10: Overheating

- The projector features an overheat protection mechanism. If the temperature exceeds the safe threshold, the device will either enter forced sleep mode or increase the fan speed, which may lead to louder operational noise.
- Do not block air vents or cooling fans.
- Keep the area around the projector clear of obstructions.
- Clean the air intake vents regularly to remove dust buildup.

Tips

As a high - tech product, the projector combined with optical, mechanical and electronic components and equipped with a protective and complicated circuit inside. To quickly solve your problems and to prevent improper using and settings please follow operations below. If your problems or enquiries cannot be eliminated after reading the table, please do not hesitate to contact us.



Website

www.aunstore.com



Whatsapp

+86 15920076893



Email: kp@ aunstore.com



Youtube: AUNProjector



WhatsApp: +86 15920076893



Telegram: +86 18124179670

Disposal and Recycling Information

- This symbol indicates that, under local laws and regulations, this product and/or its battery must be disposed of separately from household waste.on.co.
- At the end of its service life, please take the product to a designated collection point operated by your local authorities.
- Separate collection and recycling helps conserve natural resources and ensures that materials are processed in a way that safeguards human health and the environment. For details on AUN's recycling program, collection locations, restricted substances, and other environmental efforts, please visit our website at www.aunstore.com



• EU Compliance Statement

This product complies with the EMC Directive 2014/30/EU and the Electromagnetic Compatibility Regulations 2016.

• AUN 's EU Representative:

78 avenue des Champs Elysees Bureau 326, 75008, Paris, Paris, France

Email: mjcm190928@gmail.com



• Compliance Notice

Unauthorized changes or modifications to this product will invalidate AUN's electromagnetic compatibility (EMC) and wireless certifications, and may revoke your right to operate the device.

EU Declaration of Conformity

DECLARATION OF CONFORMITY
WITH BELOW LISTED COMMUNITY LEGISLATION AND HARMONIZED
STANDARDS TO SATISFY THE SAFETY, QUALITY AND REGULATORY
REQUIREMENTS OF THE BELOW SPECIFIED PRODUCT

Item	Details
Manufacturer	Shenzhen Lanbian Technology Co., Ltd.
Address	Building 2, No. 139, Baizhi North Road, Ping'an District, Shenzhen, Guangdong Province, China
Test Standards	EN 301 489-1 V2.2.3 EN 301 489-17 V3.2.4 EN IEC 62368-1:2020+A11:2020 EN IEC 62311 EN 300 328 EN 50665



Warning: Do not look directly into the lens



MJCM SARL
78 avenue des Champs Elysees Bureau 326, PARIS, FR
mjcm190928@gmail.com

Projector Cleaning and Maintenance



- To ensure optimal viewing experience and extend the product lifespan, please clean the projector regularly.



- If any parts of the projector require replacement, please contact your dealer or our qualified customer service team.



- Before cleaning or performing maintenance on the projector, please turn off the device and unplug the power cord.

Helpful Tips

- For exceptional clarity and optimal performance, it is recommended to operate the projector in a dark environment.
- Please note that the projector will produce fan noise during operation for heat dissipation. This noise will not impact your viewing experience when connected to an external audio device.
- This projector is ideal for home entertainment, including video playback, photo viewing, and gaming.
- To preserve the performance and reliability of the projector, maintain a minimum clearance of 30 cm between the projector and the surrounding walls to ensure proper ventilation.

TECHNICAL SUPPORT OR OTHER! PLEASE CONTACT US!



Website

www.aunstore.com



Whatsapp

+86 15920076893